

## Working safely with cut-off machines

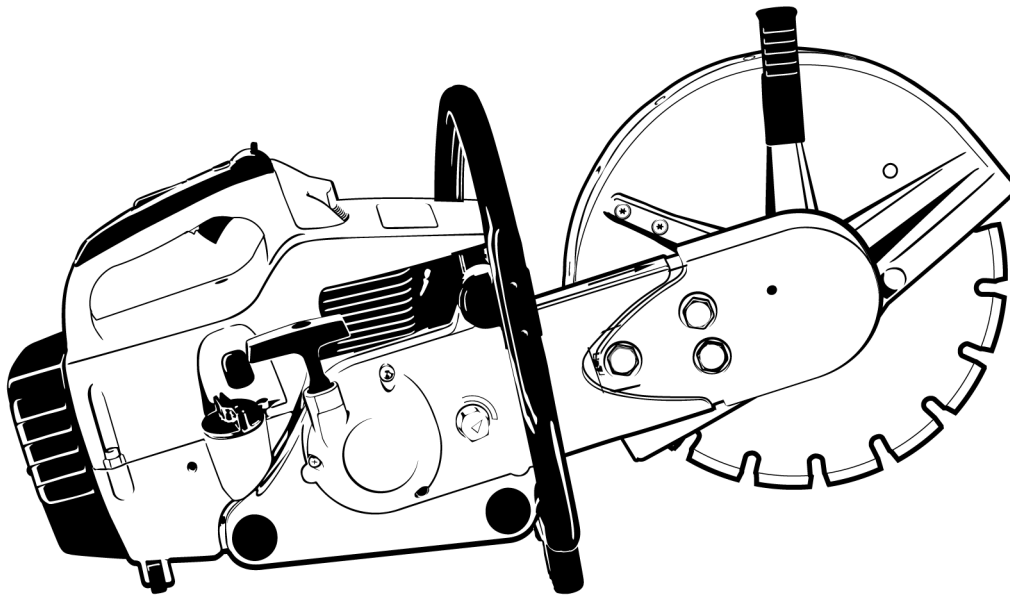



## Contents

Safety Precautions and Working Techniques	2
Sample applications	9
Cutting wheels	12
Composite resin cutting wheels	12
Diamond cutting wheels	13
Maintenance and Care	16
Main Parts	18

This brochure contains the safety precautions and working techniques described in the Instruction Manuals for STIHL cut-off machines.

The chapter "Main parts of the machine" shows the TS 420 cut-off machine as an example. Other cut-off machines may have different controls.

This brochure contains references to chapters in the Instruction Manuals for the specific machines.

Thus the Instruction Manual for the respective cut-off machine and the information sheets enclosed with the cut-off wheel must be observed.

If you still have questions after reading this brochure, please contact your STIHL servicing dealer.



## Safety Precautions and Working Techniques



Special safety precautions must be taken when working with a cut-off machine, due to the very high rotational speed of the cutting wheel.



It is important that you carefully read the entire Instruction Manual before using the machine for the first time and keep it in a safe place for future reference. Non-observance of the following safety precautions may cause serious or even fatal injury.

Observe the national safety regulations issued, for example, by the employers' liability insurance association, social security institutions, occupational safety and health authorities or other organizations.

If you have never used a power tool before: have your STIHL dealer or other specialist show you how to operate the machine – or attend one of the special training courses.

Minors should never be allowed to use the machine – except for young trainees over the age of 16 when working under supervision.

Keep children, animals and bystanders well away from the machine.

When not using the machine, it must be laid down in such a way that it does not endanger anyone. Ensure that the machine cannot be used without authorization.

The user is responsible for accidents or risks involving third parties or their property.

The machine should only be provided or loaned to people familiar with this model and its operation. The Instruction Manual should always be handed over with the machine.

Use of machines that emit noise may be restricted in terms of time by national and/or on-site, local regulations.

The machine may only be operated by people who are fit, in good physical health and in good mental condition.

If you have any condition that might be aggravated by strenuous work, check with your doctor before operating a machine.

If you have a pacemaker: The ignition system of your machine produces an electromagnetic field of very low intensity. An effect on individual pacemaker types cannot be excluded entirely. STIHL recommends that you consult your doctor and the manufacturer of your pacemaker in order to avoid health hazards.

Anyone who has consumed alcohol, medicines affecting their ability to react or drugs must not operate the machine.

Postpone the work if the weather is bad (snow, ice, wind) – **higher risk of accidents!**

The machine may only be used for cutting. It is not suitable for cutting wood or wooden objects.

Asbestos dust is extremely toxic - the machine must therefore **never be used to cut asbestos!**

Other uses are not permitted and may lead to accidents or damage to the machine.

Never modify the machine in any way, as this could be extremely dangerous. STIHL excludes all liability for personal injury and damage to property caused while using unauthorized attachments.

Only use cutting wheels and attachments which have been approved by STIHL for this machine or which are technically equivalent. Contact a dealer if in doubt. Only use high-quality cutting wheels and attachments. Otherwise there may be a risk of accidents or damage to the machine.

STIHL recommends the use of genuine STIHL cutting wheels and attachments. These have been optimized for the product and the user's requirements.

Do not use high-pressure cleaners to clean the machine. The hard water jet can damage parts of the machine.

Do not spray the machine with water.



Never use circular saw blades, carbide, rescue or wood cutting attachments or saws of any kind – **these may cause fatal injuries!** Instead of uniformly removing particles as when cutting with a cutting wheel, the teeth of a circular saw blade may snag in the material. This causes the machine to react in a highly aggressive manner with uncontrolled and extremely dangerous kickback.

### Clothing and equipment

Wear proper protective clothing and equipment.



Clothing must be sturdy and snug-fitting, but allow complete freedom of movement. Wear snug fitting clothing with cut-retardant pads – an over-all, not a loose-fitting jacket.

When cutting steel, always wear clothing made of barely flammable material (e.g., leather or cotton with flame-retardant finish) – no manmade fibers – **risk of fire due to flying sparks!**

Ensure that there are no flammable deposits (chips, fuel, oil, etc.) on the clothing.

Do not wear clothing that could become trapped in moving parts of the machine – no scarves, no neckties, no jewelry. Long hair must be tied up and covered.



Wear **safety boots** with steel toe caps and non-slip soles.



Wear a **hard hat** whenever there is any risk of falling objects. Wear a face shield and always wear **safety glasses** – danger due to flying objects.

A face mask alone is not sufficient to protect the eyes.

Dust (e. g., crystalline material from the object being cut), fumes and smoke may be produced while cutting - **health hazard!**

Always wear a **dust mask** if dust is generated.

If fumes or smoke are anticipated (e. g., when cutting composite materials), wear **respiratory protection**.

Wear "personal" **hearing protection** – e. g., ear defenders.



Wear **heavy-duty, non-slip gloves** – preferably made of leather.

STIHL can supply a comprehensive range of protective clothing and equipment.

### Transporting the machine

Always stop the engine.

Carry the machine only by the top handle – cutting wheel towards the rear – with the hot muffler facing away from the body.

Avoid touching hot parts of the machine, especially the surface of the muffler – **risk of burns!**

Never transport the machine with the cutting wheel fitted - **it may break!**

In vehicles: Properly secure your machine to prevent turnover, damage and fuel spillage.

### Refueling



**Gasoline is an extremely flammable fuel** – keep clear of naked flames and fire – do not spill any fuel – no smoking.

**Switch off the engine** before refueling.

Never refuel the machine while the engine is still hot – the fuel may spill over – **risk of fire!**

Open the fuel filler cap carefully so that any excess pressure is relieved gradually and fuel does not splash out.

The machine may only be refueled in a well ventilated place. Clean the machine immediately if fuel is spilled. Change your clothes immediately if they are contaminated with fuel.

Dust may collect on the engine unit, particularly around the carburetor. If the dust is soaked with gasoline, it may catch fire. For this reason, ensure that the dust is always removed.



Check for fuel leakage while refueling and during operation. Never start the engine if fuel has been spilled or is leaking – **Fatal burns may result!**

Various cut-off machines may be equipped with various filler caps:

### Bayonet filler cap

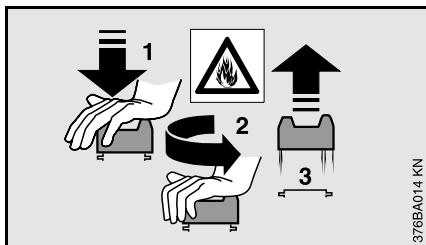

Never use a tool to open or close the bayonet filler cap. This could damage the cap and cause fuel to leak out.

Secure the bayonet filler cap tightly after refueling.

### Threaded filler cap



Close the threaded filler cap as tightly as possible after refueling.

This helps reduce the risk of unit vibrations causing an incorrectly tightened filler cap to loosen or come off and spill quantities of fuel.

## Cut-off machine, spindle bearing

A faultless spindle bearing ensures the radial and axial runout of the diamond cutting wheel – have this checked by a dealer if necessary.

## Cutting wheels

### Selecting cutting wheels

Cutting wheels must be approved for freehand cutting. Do not use any other cutting wheels or attachments - **risk of accidents!**

Cutting wheels are suitable for varying materials: Observe the cutting wheel codes.

STIHL generally recommends wet cutting.

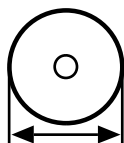

Observe the outer diameter of the cutting wheel.

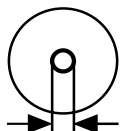

The diameter of the spindle hole of the cutting wheel and the shaft of the cut-off machine must match.

Check spindle hole for damage. Do not use cutting wheels with a damaged spindle hole – **Risk of accident!**



The permissible speed of the cutting wheel must be equal to or greater than the maximum spindle speed of the cut-off machine! Refer to the chapter "Specifications".

Before fitting a used cutting wheel, check that it is not cracked, chipped, or uneven, and does not display any signs of core fatigue or overheating (discoloration); check also that there are no damaged or missing segments and that the spindle bore is not damaged.

Never use a chipped, cracked or warped cutting wheel.

Substandard and/or unapproved diamond cutting wheels can shimmy during cutting. This shimming can cause such diamond cutting wheels to be abruptly braked or become stuck in the cut – **Danger of kickback! Kickback can result in fatal cuts!** Diamond cutting wheels that shimmy constantly or even only intermittently must be replaced immediately.

Never straighten diamond cutting wheels.

Never use a cutting wheel that has been dropped – a damaged cutting wheel may break – **risk of accident!**

Observe the use-by date where resin cutting wheels are concerned.

### Mounting cutting wheels

Check the cut-off machine spindle, do not use cut-off machines with damaged spindles – **risk of accident!**

Note the arrows indicating the direction of rotation on diamond cutting wheels.

Position front thrust washer – tighten tensioning nut – turn cutting wheel by hand, in the process making a visual inspection for radial and axial runout.

### Storing cutting wheels

Store cutting wheels in a dry, frost-free place, on a flat surface, at constant temperatures – **danger of breakage and shattering!**

Always protect cutting wheels against sudden impact with the floor or objects.

### Before starting

Check that the cut-off machine is in good condition - refer to the corresponding chapters in the Instruction Manual:

- The cutting wheel must be suitable for the material to be cut. It must be in good condition and fitted correctly (direction of rotation, securely seated).
- Check that the deflector is secure - consult a STIHL servicing dealer if it is loose
- The throttle trigger and throttle trigger interlock must move easily – throttle trigger must return automatically to the idle position when released
- Slide control / master control / stop switch must move easily to **STOP** or **0**
- Check that the spark plug boot is secure. A loose boot can lead to flying sparks which may ignite the escaping fuel/air mixture – **risk of fire!**

- Never attempt to modify the controls or safety devices
- Keep the handles dry and clean – free from oil and dirt – for safe control of the cut-off machine

The machine should only be used if it is in good working order – **risk of accident!**

### Starting the engine

Move at least 3 meters away from the place at which the machine was refueled and never start the machine in enclosed spaces.

The machine may only be used on level ground. Ensure a firm and secure footing and hold the machine firmly. The cutting wheel must not touch any objects or the ground and must not be in the cut.

The cutting wheel may begin to rotate as soon as the machine is started.

The machine is operated by only one person. There should not be any other person within the working area, not even when starting the machine.

Do not drop-start the engine – start as described in the Instruction Manual.

The cutting wheel continues to run for some time after the throttle trigger has been released – **Risk of injury due to coasting effect!**

### Holding and guiding the machine

The cut-off machine may only be used for freehand cutting or when mounted on a STIHL cut-off machine cart.

### Hand-held cutting

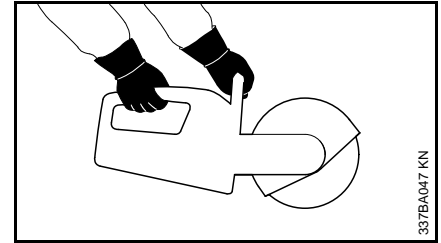

Always hold the machine **firmly with both hands**: Right hand on the rear handle – even if you are left-handed. To ensure reliable control, wrap your thumbs tightly around the handlebar and handle.

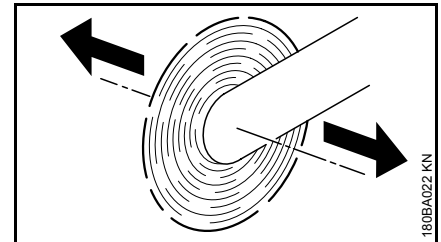

When a cut-off machine with rotating cutting wheel is moved in the direction of the arrow, a force is produced which causes the machine to tip sideways.

The object that is to be cut must be positioned firmly; always guide the machine to the workpiece – never vice versa.

### Cut-off machine cart

STIHL cut-off machines can be mounted on a STIHL cut-off machine cart.

## Deflector

---

The adjusting range of the deflector is determined by a stop pin. Never attempt to push the deflector over the stop pin.

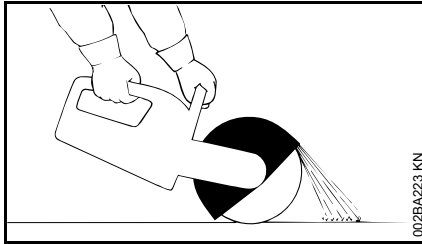

Set the deflector correctly for the cutting wheel: so that particles of material are guided away from the user and machine.

Note the direction in which the cut particles are ejected.

## During work

---

In the event of impending danger or in an emergency, switch off the engine immediately by moving the slide control / master control / stop switch to **STOP** or **0**.

Check for correct idling, so that the cutting wheel is no longer driven when the throttle trigger is released and comes to a complete halt.

Check and/or correct the idle setting regularly. Have the machine repaired by a STIHL servicing dealer if the cutting wheel continues to turn nevertheless.

Ensure that the working area is clear – watch out for obstacles, holes and pits.

Beware of **slipping** on ice, water, snow or uneven ground!

Never work on a ladder or on any other unsteady support. Do not work above shoulder height and never operate the machine with one hand - **risk of accidents!**

Ensure you always have a firm and safe footing.

Do not work alone – keep within calling distance of others in case help is needed.

Never allow anyone in the working area and keep well away from other people to protect them from noise and flying objects.

More care and attention than usual are required when wearing ear protection, as sounds warning you of impending danger (shouts, beeps, etc.) cannot be heard properly.

If you get tired, take a break in good time.

Work calmly and methodically – only with good lighting and visibility. Take care not to endanger other people!



Your power tool produces toxic exhaust fumes as soon as the engine is running. These gases may be colorless and odorless and may contain unburnt hydrocarbons and benzene. Never run the engine indoors or in poorly ventilated areas, even if your model is equipped with a catalytic converter.

Ensure proper ventilation when working in trenches, hollows or other confined locations – **risk of serious or fatal injury from breathing toxic fumes!**

If you feel sick, if you have a headache, vision problems (e.g., your field of vision gets smaller), hearing problems, dizziness or inability to concentrate, stop work immediately. Such symptoms may be caused by an excessively high concentration of exhaust emissions – **risk of accident!**

**No smoking** when working with or near the machine - **risk of fire!**

If the machine is subjected to unusually high loads for which it was not designed (e.g., heavy impact or a fall), always check that it is in good condition before continuing work - refer also to the section "Before starting". Check the fuel system for leaks and make sure the safety devices are working properly. Never use the machine if it is not in good condition. Consult a servicing dealer if in doubt.

Do not work in the starting throttle position, as the engine speed cannot be controlled in this position.

Never touch a rotating cutting wheel with your hand or any other part of the body.

Examine the workplace. Avoid all danger due to damaged piping or electrical wiring.

The machine must not be used near inflammable substances or gases.

Never use the machine to cut inside pipes, metal troughs or other containers unless you are absolutely sure that they do not contain any volatile or inflammable substances.



Never leave the machine unattended with the engine running. Switch off the engine before leaving the machine (e. g., for a break).

Before putting the cut-off machine down on the ground:

- Switch off engine
- Wait until the cutting wheel has come to a standstill or brake the cutting wheel until it comes to a standstill by carefully touching a hard surface (e. g., concrete slab)



Inspect cutting wheel frequently – replace immediately if there is evidence of cracking, warping or other damage (e. g., overheating) – **risk of accident** due to breakage!

In the event of changes in cutting behavior (e. g., increased vibration, reduced cutting performance), stop work and eliminate the causes of the changes.

### Reactive forces

The most frequently occurring reactive forces are kickback and pull-in.

### Dangers of kickback

**Kickback can result in fatal cuts.**

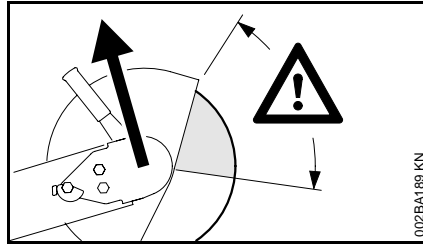

Kickback occurs when the cut-off machine is suddenly thrown up and back in an uncontrolled arc towards the operator.

### Kickback occurs if, for example, the cutting wheel

- becomes jammed – above all in the upper quarter
- is severely braked through frictional contact with a solid object

### Reduce the risk of kickback

- Work cautiously and methodically
- Hold the cut-off machine firmly with both hands and maintain a secure grip

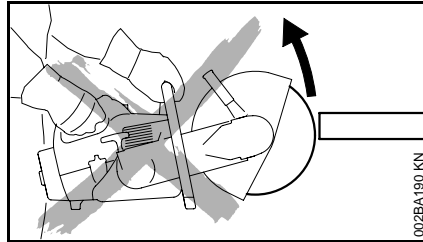

- Do not use the upper quarter of the cutting wheel for cutting. The cutting wheel must be introduced into the cut with extreme care, without twisting and without pushing

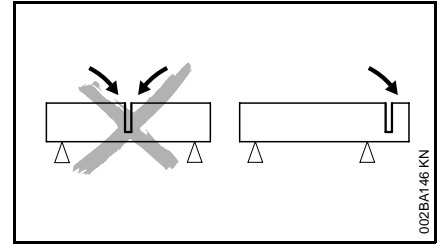

- Always be aware that the object to be cut may move and other factors may cause the cut to close and jam the cutting wheel.
- The object to be cut must be secured and supported so that the cut remains open during and after cutting
- Work with water and wet cutting when using diamond cutting wheels
- Depending on version, composite resin cutting wheels are suitable for dry cutting or wet cutting only. Always use wet cutting with composite resin cutting wheels that are suitable only for wet cutting

### Pulling away

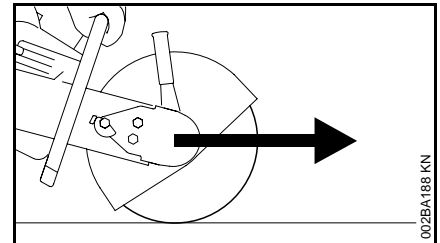

The machine pulls forward, away from the user, when the cutting wheel touches the object to be cut from above.

## Working with the cut-off machine



The cutting wheel must be guided straight in the cut, without wedging. Never exert lateral pressure on the cutting wheel.



Do not use the cutting wheel for lateral grinding or scrubbing.

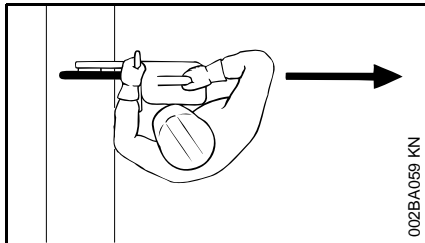

Do not stand in line with the cutting wheel.

Do not lean too far forwards and never bend over the cutting wheel, especially when the deflector has been pulled back.

Don't cut above shoulder height.

The cut-off machine may only be used for cutting. It must not be used as a lever or shovel.

Do not press down on the cut-off machine.

Always decide the cutting direction before positioning the cutting wheel. After that, do not change the cutting direction. Avoid knocks and bumps with

the machine while in the cut – do not drop the machine into the cut – **danger of breakage!**

**Diamond cutting wheels:** If cutting performance begins to deteriorate, check the sharpness of the diamond cutting wheel, sharpen as needed. To do this, briefly cut through abrasive material, e. g., sandstone, aerated concrete or asphalt.

At the end of the cut, the cut-off machine is no longer supported by the cutting wheel in the cut. The machine's weight must be borne by the user, otherwise you **may lose control of the machine!**



When cutting steel: glowing metal particles **may cause fires!**

Keep water and sludge away from electric cables - **risk of electric shocks!**

To obtain a clean cut: the cutting wheel should be pulled into the workpiece if possible or moved back and forth in cutting direction. It must never be pushed.

Work with water and wet cutting when using diamond cutting wheels – e. g., use STIHL water attachment.

Depending on version, composite resin cutting wheels are suitable for dry cutting or wet cutting only.

Work with water and wet cutting when using composite resin cutting wheels that are suitable only for wet cutting – e. g., use STIHL water attachment.

Use dry cutting when using composite resin cutting wheels that are suitable only for dry cutting. If composite resin

cutting wheels of this type become wet, their cutting performance is reduced and they become dull. If composite resin cutting wheels of this type become wet while working (e. g., due to puddles or water in pipes), do not increase the cutting pressure, but continue working with the same pressure – **risk of breakage!** Wet composite resin cutting wheels must be used up immediately.

## Cut-off machine cart

Clear a path for the cart. If the cart is pushed over objects, the cutting wheel may become wedged in the cut and **shatter!**

## Vibrations

Prolonged use of the power tool may result in vibration-induced circulation problems in the hands ("white finger disease").

No general recommendation can be given for the length of usage because it depends on several factors.

The period of usage is prolonged by:

- Hand protection (wearing warm gloves)
- Work breaks

The period of usage is shortened by:

- Any personal tendency to suffer from poor circulation (symptoms: frequently cold fingers, tingling sensation)
- Low outside temperatures
- Amount of gripping force (holding the power tool tightly restricts circulation)

Users who use the machine periodically or for long periods or users who repeatedly experience corresponding symptoms (e.g., tingling sensation in fingers), should undergo a medical examination.

### Maintenance and repairs

The machine must be serviced regularly. Do not attempt any maintenance or repair work not described in the Instruction Manual. All other work should be carried out by a servicing dealer.

STIHL recommends that maintenance and repair work be carried out only by authorized STIHL dealers. STIHL dealers receive regular training and are supplied with technical information.

Use only high-quality replacement parts, in order to avoid the risk of accidents or damage to the machine. Contact a dealer if in doubt.

STIHL recommends the use of genuine STIHL spare parts. Such parts have been optimized for the machine and the user's requirements.

Before starting any maintenance or repair work and before cleaning the machine, always **stop the engine and disconnect the spark plug boot – risk of injury** if the engine starts up inadvertently! – Exception: adjustment of carburetor and idle speed.

To reduce the **risk of fire** due to ignition outside the cylinder, move the slide control / stop switch to **STOP** or **0** before turning the engine over on the starter with the spark plug boot removed or the spark plug unscrewed.

Do not service or store the machine near a naked flame – **risk of fire** due to the fuel.

Check fuel cap regularly for tightness.

Use only spark plugs that are in perfect condition and have been approved by STIHL – see Specifications.

Inspect ignition lead (insulation in good condition, secure connection).

Check that the muffler is in perfect working condition.

Do not use the machine if the muffler is damaged or missing - **risk of fire! – Hearing damage!**

Never touch a hot muffler – **risk of burns!**

Check the rubber buffers underneath the machine - the housing must not rub against the ground - **risk of damage!**

The condition of the antivibration elements influences vibration behavior – inspect antivibration elements periodically.

## Sample applications

### Water must always be used for wet cutting when working with diamond cutting wheels

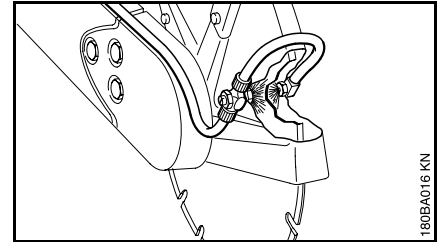

### Extend service life and increase cutting speed

Always ensure a supply of water to the cutting wheel.

### Bind dust

The cutting wheel must be supplied with at least 0.6 l/min of water.

### Water attachment

- Water attachment on the machine for all types of water supplies
- Pressurized water tank 10 l for binding dust
- water tank usable on the cut-off machine cart for binding dust

### Use composite resin cutting wheels with or without water – depending on version

Depending on version, composite resin cutting wheels are suitable for dry cutting or wet cutting only.

### Composite resin cutting wheels suitable only for dry cutting

During dry cutting, wear a suitable dust mask.

If fumes or smoke are anticipated (e. g., when cutting composite materials), wear **respiratory protection**.

### Composite resin cutting wheels suitable only for wet cutting



Use cutting wheel only with water.

To bind dust, the cutting wheel must be supplied with at least 1 liter of water per minute. To avoid a reduction in cutting performance, the cutting wheel must be supplied with not more than 4 liters of water per minute.

After using the cutting wheel, the wheel should be allowed to continue spinning at operating speed for approx. 3 to 6 seconds without water in order to spin off the water remaining on it.

- Water attachment on the machine for all types of water supplies
- Pressurized water tank 10 l for binding dust
- water tank usable on the cut-off machine cart for binding dust

### Observe with diamond and composite resin cutting wheels

#### Object to be cut

- Must be fully supported
- Must be secured so it cannot roll or slip off
- Must be prevented from vibrating

#### Severed parts

With openings, recesses, etc., the sequence of the cuts is important. Always make the last cut so that the cutting wheel does not become jammed and so that the operator is not endangered by the severed or separated part.

If necessary, leave small ridges that hold the part that is to be separated in position. Break these ridges later.

Before finally separating the part, determine:

- how heavy the part is
- how it can move after separation
- whether it is under tension

When breaking out the part, do not endanger assistants.

### Cut in several passes

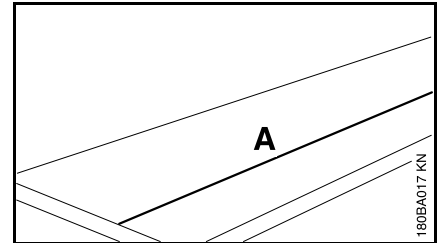

- Mark cutting line (A)

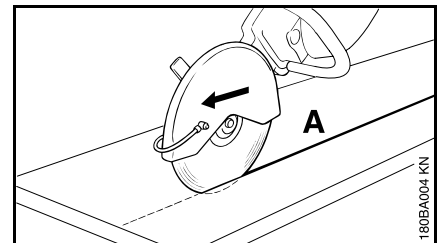

- Work along the cutting line. When making corrections, do not tilt the cutting wheel, but always set the cutting wheel against the workpiece anew – the cutting depth for each operation should not exceed 5 to 6 cm. Cut thicker material in multiple operations

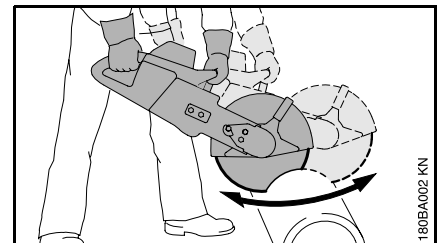

- sever large wall thicknesses with even back and forth movements

## Cutting plates

- Secure the plate on a non-slip surface

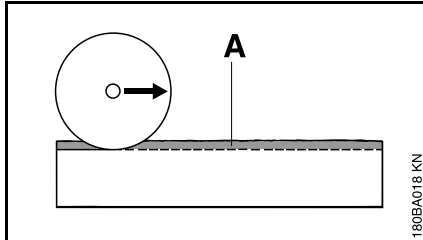

- Grind a guide groove (A) along the line marked

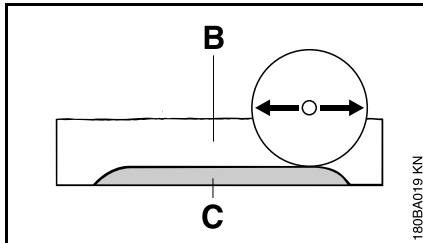

- Make the cut (B) deeper with even back and forth motions
- Leave a "hinge" (C)
- First sever the plate at the cut ends so that no material breaks away
- Break plate

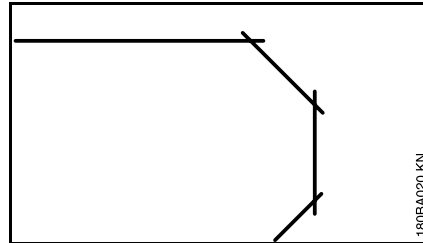

- Make curves in multiple operations – make certain that the cutting wheel does not tilt

## Cutting round and hollow bodies

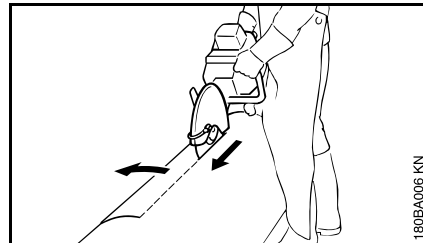

- Secure pipes, round bodies, etc. against rolling away
- when determining the cutting line, avoid reinforcement, especially in the direction of the severing cut
- Grind a guide groove along the line marked
- Make cuts deeper with even back and forth motions – feed with full cutting depth along the guide groove – for small corrections of direction, do not tilt the cutting wheel, but always position it anew instead – if necessary, leave small ridges that hold the part that is to be separated in position. Break these ridges later

## Shaping pipe

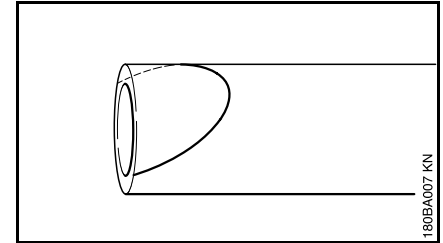

- Mark a cutting line

 Manual cutting along this line requires particular caution and precision.

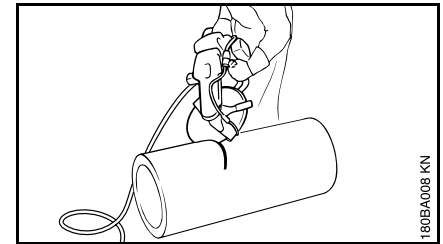

- Grind a guide groove along the marked cutting line – do this by starting at the apex and cut outward on both sides
- Cut into pipes, round bodies, etc. in the area at the ends of the cutting line, so that the material does not break away
- Make cuts deeper with even back and forth motions – start at the apex and cut outwards on both sides – feed with full cutting depth along the guide groove – for small corrections of direction, do not tilt the cutting wheel, but always position it anew instead – if necessary, leave small

ridges that hold the part that is to be separated in position. Break these ridges later

## Cutting wheels

Cutting wheels are exposed to extremely high loads especially during freehand cutting.

The cutting wheels, which have been developed by STIHL in cooperation with renowned manufacturers of abrasive wheels, are of high quality and tailored precisely to the respective intended use as well as the engine performance of the cut-off machine.

They are of consistently outstanding quality.

### Transport and storage

- Do not expose cutting wheels to direct sunshine or other thermal stresses during transport and storage
- Avoid jolting and impacts
- Stack cutting wheels flat on a level surface in the original packaging in a dry place where the temperature is as constant as possible
- Do not store cutting wheels in the vicinity of aggressive fluids
- Store cutting wheels in a frost-free place

## Composite resin cutting wheels

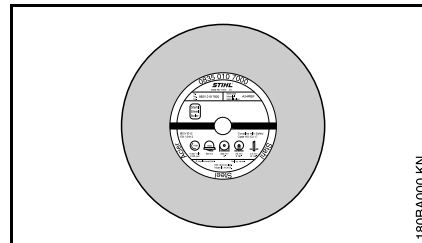

The proper selection and use of composite resin cutting wheels ensures economical use and avoids accelerated wear. The code on the

- label
- of the packaging (table with recommendations for use) is an aid to selection

STIHL composite resin cutting wheels are suitable, depending on the version, for cutting the following materials:

- Asphalt
- Concrete
- Stone
- ductile cast iron pipes
- Steel

STIHL composite resin cutting wheels are not suitable for cutting railway tracks.

## Diamond cutting wheels

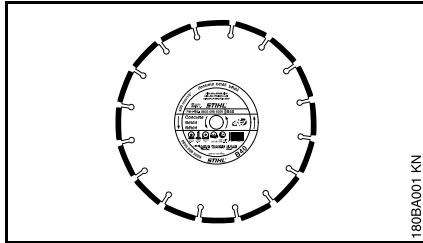

The proper selection and use of diamond cutting wheels ensures economical use and avoids accelerated wear. The code on the

- label
- of the packaging (table with recommendations for use) is an aid to selection

STIHL diamond cutting wheels are suitable, depending on the version, for cutting the following materials:

- Asphalt
- Concrete
- Stone (hard stone)
- abrasive concrete
- Fresh concrete
- Clay brick
- Clay pipe

STIHL diamond cutting wheels are not suitable for cutting metal.

## Product Codes

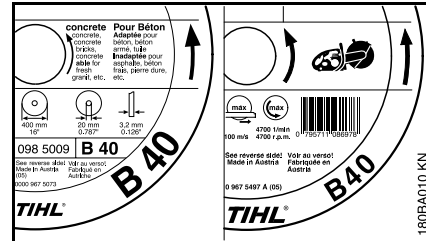

The product code is a combination of one to four letters and numbers:

- the letters denote the main field of application of the cutting wheel

Letter	Main field of application
<b>A</b>	Asphalt
<b>B</b>	Concrete
<b>BA</b>	Concrete, asphalt
<b>S</b>	Stone (hard stone)
<b>SB</b>	Hard stone, concrete

- the numbers denote the performance class of the STIHL diamond cutting wheel

## Axial and radial run-out

A faultless spindle bearing of the cut-off machine is necessary for a long service life and efficient functioning of the diamond cutting wheel.

Using the cutting wheel on a cut-off machine with a faulty spindle bearing can lead to deviations in radial and axial run-out.

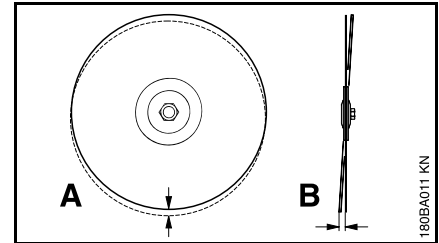

An excessively high radial run-out deviation (**A**) overloads individual diamond segments, which overheat in the process. This can lead to stress cracks in the parent wheel or to annealing of individual segments.

Deviations in axial run-out (**B**) result in higher thermal loading and wider cuts.

**Troubleshooting****Cutting wheel**

<b>Error</b>	<b>Cause</b>	<b>Remedy</b>
ragged edges or cut surfaces, crooked cut heavy wear on the sides of the segments	Deviation in radial or axial run-out Cutting wheel gyrates	Contact a servicing dealer <sup>1)</sup> use a new cutting wheel
ragged edges, crooked cut, no cutting performance, generation of sparks	Cutting wheel is dull; built-up edges with cutting wheels for stone	Sharpen cutting wheels for stone by briefly cutting through abrasive materials; replace cutting wheel for asphalt with a new one
poor cutting performance, high segment wear	Cutting wheel is turning in the wrong direction	Mount cutting wheel so that it turns in the right direction
Breakdowns or tears in the parent wheel and segment	Overloading	use a new cutting wheel
Undercut	Cutting in the wrong material	use new cutting wheel; observe separating layers of various materials

<sup>1)</sup> STIHL recommends STIHL servicing dealers



## Undercut

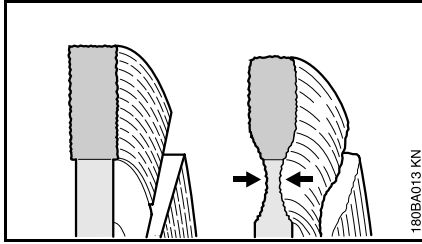

Do not cut into the base course (frequently chipped stones and gravel) when cutting roadway pavement – cutting in chipped stones and gravel is revealed by light-colored dust – excessive undercut may occur as a result – **Danger of shattering!**

## Built-up edges, sharpen

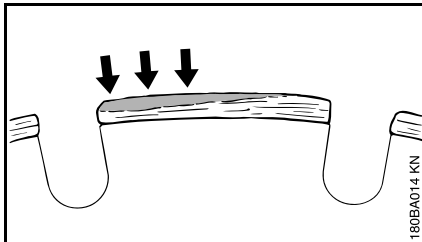

Built-up edges take the form of a light gray deposit on the tops of the diamond segments. This deposit on the segments clogs the diamonds and blunts the segments.

Built-up edges can form:

- when cutting extremely hard materials, e. g., granite
- with incorrect handling, e. g., excessive feed effort
- if excessively large cross-sections are cut without pendulum cutting (movement back and forth in the cutting plane)

Built-up edges increase vibration, reduce cutting performance, and cause formation of sparks.

At the first signs of built-up edges, immediately "sharpen" the diamond cutting wheel – to do this, briefly cut through abrasive material such as sandstone, aerated concrete or asphalt.

Addition of water prevents the formation of built-up edges.

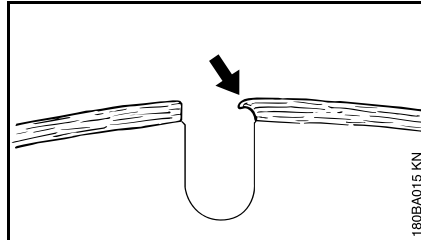

If work continues with dull segments, these may soften due to the high heat generated – the parent wheel is annealed and its strength is compromised – this can lead to stresses that are clearly recognizable by gyrations of the cutting wheel. Do not continue to use the cutting wheel – **Risk of accident!**

## Maintenance and Care

The following maintenance intervals apply in normal operating conditions. The specified intervals must be shortened accordingly when working for longer than normal or under difficult cutting conditions (extensive dust, etc.).		before starting work	at the end of work and/or daily	Whenever tank is refilled	Weekly	Monthly	Yearly	If faulty	If damaged	As required
Complete machine	Visual inspection (condition, leaks)	X		X						
	Clean		X							
Operating elements	Check operation	X		X						
Fuel pick-up body in fuel tank	test, check							X		
	Replace						X		X	X
Fuel tank	Clean					X				
Ribbed V-belt	Clean / retension					X				X
	Replace								X	X
Air filter (all filter components)	Replace	<b>Only if there is a noticeable loss of engine power</b>								
Cooling air intake slits	Clean		X							
Cylinder fins	Have them cleaned by a specialist dealer <sup>1)</sup>						X			
Spark arresting screen <sup>2)</sup> in muffler	test, check		X							
	Clean or replace									X
Water attachment	test, check	X						X		
	Have them maintained by a specialist dealer <sup>1)</sup>								X	
Carburetor	Check idle adjustment – abrasive wheel must not rotate	X		X						
	Readjust idle speed									X
Spark plug	Adjust electrode gap							X		
	Replace after 100 hours' operation									
All accessible screws, nuts and bolts (not adjusting screws)	Retighten		X							X

The following maintenance intervals apply in normal operating conditions. The specified intervals must be shortened accordingly when working for longer than normal or under difficult cutting conditions (extensive dust, etc.).		before starting work	at the end of work and/or daily	Whenever tank is refilled	Weekly	Monthly	Yearly	If faulty	If damaged	As required
Antivibration elements	test, check	X						X		X
	Have them replaced by a specialist dealer <sup>1)</sup>								X	
Abrasive wheel	test, check	X		X						
	Replace								X	X
Supports/rubber buffers (underneath the machine)	test, check		X							
	Replace								X	X
Safety information sticker	Replace								X	

<sup>1)</sup> STIHL recommends STIHL servicing dealers

<sup>2)</sup> present only in some countries

## Main Parts

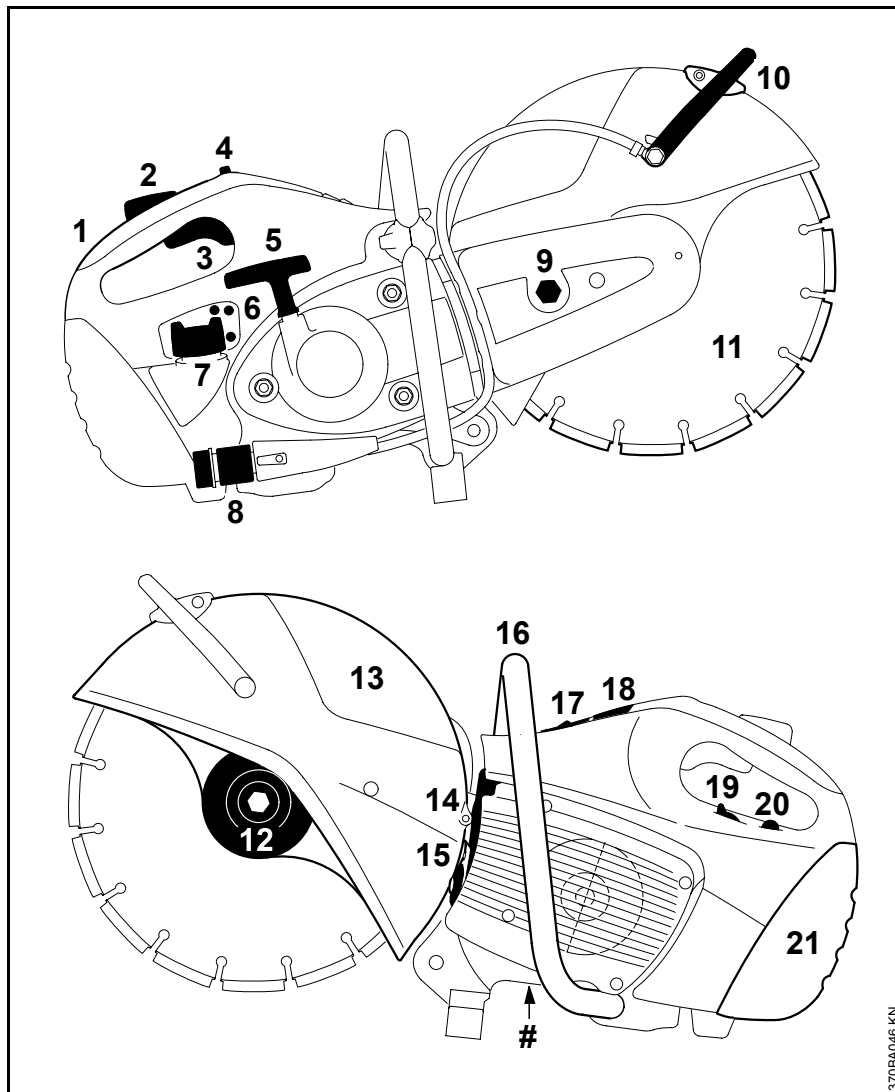

- 1 Rear handle
- 2 Throttle trigger interlock
- 3 Throttle trigger
- 4 Slide control
- 5 Starter grip
- 6 Carburetor adjusting screws
- 7 Filler cap
- 8 Water attachment
- 9 Tensioning nut
- 10 Adjusting lever
- 11 Cutting wheel
- 12 Front thrust washer
- 13 Deflector
- 14 Muffler
- 15 Spark arresting screen (present only in some countries)
- 16 Handlebar
- 17 Decompression valve
- 18 Cap for spark plug boot
- 19 Choke lever
- 20 Fuel pump
- 21 Filter cover
- # Serial number

3.70BAQ46 KN







0457-186-0121

englisch



[www.stihl.com](http://www.stihl.com)



0457-186-0121